

# FUNCTIONAL REQUIREMENTS

## 7.9 ROOF COVERINGS – TRADITIONAL SLATE AND TILES

### Workmanship

- i. All workmanship must be within the tolerances defined in Chapter 1 of this Manual.
- ii. All work is to be carried out by a technically competent person in a workmanlike manner.
- iii. Certification is required for any work completed by an approved installer.

### Materials

- i. All materials should be stored correctly in a manner that will not cause damage or deterioration of the product.
- ii. All materials, products and building systems shall be appropriate and suitable for their intended purpose.
- iii. The structure shall, unless specifically agreed otherwise with the Warranty provider, have a life of not less than 60 years. Individual components and assemblies, not integral to the structure, may have a lesser durability, but not in any circumstances less than 15 years.

### Design

- i. The design and specifications shall provide a clear indication of the design intent and demonstrate a satisfactory level of performance.
- ii. Roof coverings must prevent any external moisture from passing into the internal environment of the dwelling.
- iii. Structural elements outside the parameters of regional Approved Documents A must be supported by structural calculations provided by a suitably qualified expert.
- iv. The materials, design and construction must meet the relevant Building Regulations, British Standards, Eurocodes and other statutory requirements.

### 7.9.1 Legislation and planning

Tiled and pitched roof coverings should be in accordance with the relevant Building Regulations.

The principal British Standards relevant to this document are:

- BS 5534 Code of Practice for slating and tiling (including shingles). This gives recommendations for the design, materials, application, installation and performance of slates and tiles (BS 5534 should be read in conjunction with BS 8000-6).
- BS 8000-6 Workmanship on building sites. Code of Practice for slating and tiling of roofs and claddings. This applies to the laying and fixing of clay and concrete tiles, natural and fibre cement slates and their associated fixings and accessories.
- BS 5250 Control of condensation in buildings. This describes the causes and effects of surface and interstitial condensation in buildings, and gives recommendations for control of condensation in roofs.

To ensure safe working practices during construction, the Designer should consider relevant safety regulations. These include the Construction (Design and Management) Regulations and the Health and Safety Executive's Approved Code of Practice for Management of Health and Safety at Work.

Certain advisory bodies, such as the Loss Prevention Council, Building Research Establishment Ltd (BRE) and Timber Research

and Development Association (TRADA), also produce recommendations and guidance on roof construction.

### 7.9.2 Weather exposure

#### 7.9.2.1 Rain and snow

The roof of the building shall adequately protect the building and people who use the building from harmful effects caused by precipitation and wind-driven spray. Roofs are required to resist the penetration of precipitation (rainfall) to the inside of the building, thereby preventing damage to any part of the building where it might be carried.

Most pitched roofs keep the rain and snow out of the building and give a satisfactory performance. However, it is acknowledged that similar roofs built to the same design and using identical roof materials, but in different locations, may not necessarily provide the same level of assurance since they will be subject to different weather conditions and exposure.

#### Exposure to driving rain

The UK has a high risk of severe driving rain, and even in some sheltered locations may be subject to high levels of deluge rainfall. BS 5534 defines two categories of exposure, based on the driving rain data given in BS 8104 and BR 262, and should be used for buildings up to 12m in height. For buildings over 12m in height, the influence of increased wind speeds should be taken into account using BS EN 1991-1-4: 2005+A1.

### Performance of tiles and slates

Rain penetration of the roof covering is dependent on a combination of the rainfall rate, wind speed and the ability of the roof tile or slate to resist the ingress of snow and rain water. The Designer should therefore be aware of the various means by which rain and snow can, under certain conditions, penetrate the roof covering.

These include:

- Capillary action and rain water creep
- Raindrop bounce and negative pressure rain suction
- Driving rain, deluge rain and flooding
- Surcharging of rain water over laps on long-rafter roofs
- Wind-driven snow

### Roof pitch

When determining the pitch, head-lap and/or side-lap of a tile or slate, the roof pitch is taken to be equal to the rafter pitch. Hence, all references to pitch refer to the rafter pitch, with the laid angle of the roof tile or slate always being less than roof pitch.

The actual pitch of a slate or tile should be determined in accordance with the following guidelines:

- Tile/slate to rafter pitch angles.
- Plain tiles: 7° less than rafter pitch.
- Interlocking single-lap tiles and slates: 5° less than rafter pitch.

## CHAPTER 7: Superstructure

- Double-lap fibre cement slates: 1.25° less than rafter pitch.

If the design rafter pitch is less than the minimum recommended rafter pitch for the particular tile or slate, then they can be considered as having an aesthetic function only. In such cases, the true weatherproofing of the roof system must rely on a fully supported waterproof membrane with an uninterrupted drainage path between counter battens to the eaves gutter.

### 7.9.2.2 Wind

#### Design for wind loading

When considering the wind loading on the roof covering, Designers should consult BS 5534. This provides calculation methods to assess the wind load on each tile or slate as a uniformly distributed load, and also takes into account the porosity of the tiles or slates and the effectiveness of the substrate (boarding or sarking), and/or underlay shielding, when calculating wind uplift loads. The standard method in BS EN 1991-1-4: 2005+A1 Eurocode 1. Actions on structures. General actions. Wind actions should be used to determine the basic wind speed of the site, which is then used to calculate the effective wind speed and dynamic wind pressure on the roof by applying a series of factors to account for terrain, topography, building height and length, etc.

#### Control of internal pressure

The total wind force on a roof is dependent on the pressure differential between the inner and

outer faces of the roof covering. Such pressures are significantly reduced by the use of underlay or boarding beneath tiling or slating. Its contribution towards shielding the underside of the tiles or slates from the full transmission of internal pressures means the underlay is required to have an adequate tensile strength for the specific application. The tensile strength of the underlay, its air permeability factor and the withdrawal resistance of batten nail fixings are therefore important when determining the overall resistance to wind uplift of the roof system.

#### Ridges, hips, verges and valleys

The use of mortar for the bedding of concrete or clay ridge and ridged hip tiles on concrete or clay tiles or fibre cement slates; does not provide sufficient tensile bond strength to resist wind uplift as it can be affected by a number of factors, such as wind loadings, mix of mortar, design and movement of the roof structure. The use of mortar bedding should be supplemented by suitable mechanical fixings to ensure the component is mechanically fixed.

**Note:** Dry fix ridge and hip systems are available to provide full mechanical fixing of all ridge and hip tiles to meet BS 5534 recommendations.

#### Aircraft vortices

Roofs near airports can experience high local wind load forces due to air vortices created by certain aircraft when taking off and landing, which may be greater than the wind loads calculated to BS 5534. Designers should seek advice from

the Airport Authority Planning Department when designing roof fixings in these locations, and refer to the guidance contained in BRE Digest 467 Slate and tile roofs: avoiding damage from aircraft wake vortices.

#### Calculating the fixing specification

The procedures for calculating the wind loads and determining the fixing specification for tiles and slates in accordance with BS EN 1991-1-4: 2005+A1 and BS 5534 are complex to undertake. Designers are advised to obtain a full roofing fixing specification either from the slate or tile manufacturer or by reference to the Zonal Fixing Method tables, which provide a conservative interpretation of the fixing requirements in BS 5534.

#### Zonal fixing method

The zonal method is a means of obtaining a fixing specification for roof tiles and is a simplification of the calculations defined in BS 5534 Code of Practice for slating and tiling (including shingles) and BS EN 1991-1-4: 2005+A1 Eurocode 1. Actions on structures. General actions. Wind actions. The assumptions made in the simplification process may produce a specification with more or stronger fixings than those required if the full BS 5534 calculation is used.

Zonal fixing specification	Single lap tiles	Double lap tiles
A	No fixings required	Refer to manufacturer
B	Each tile once nailed (right hand nail hole – flat tiles)	
C	Each tile twice nailed (flat tiles only)	
D	Each tile clipped	
E	Each tile once nailed and clipped	
F	Each tile twice nailed and clipped	
<p><b>Notes:</b></p> <ol style="list-style-type: none"> <li>1) The manufacturer may also specify the use of improved nails for fixing tiles, e.g., ring shank nails. Where these are required, the Zonal fixing specification letter will be marked with an asterisk, e.g., C*.</li> <li>2) Manufacturers may define additional fixing specifications to those in the table and assign fixing specification letters from 'G' onwards.</li> <li>3) In some cases, the manufacturer may specify a 'proprietary fixing system' and this will be marked 'PS'. The manufacturer should be contacted for details of the requirements for this fixing method</li> </ol>		

Table 1: Zonal fixing specification

**7.9.3 Condensation and ventilation**

**7.9.3.1 Statutory requirements**

The roof should be designed and constructed in accordance with clause 8.4 of BS 5250 and BS EN ISO 13788. Detailed information on methods to control harmful condensation is provided in BS 5250 Code of Practice for control of condensation in buildings, Section 8.4 Roofs.

Prevention of condensation in roof voids is best achieved through the provision of natural air ventilation. BS 5250 states that the Designer should take account of the following moisture sources in buildings:

- Water incorporated during the construction process (including precipitation).
- Precipitation after construction.
- Water vapour arising from the occupants and their activities.
- Temporary condensation occurring when cold weather conditions are followed by warm, humid weather.

**Sealed ceilings**

BS 9250 emphasises the importance of well-sealed ceilings as a means of curbing the transfer of moisture into a roof space by means of moisture-laden air. This means:

- The avoidance of gaps and holes in a ceiling.
- The siting of access doors or hatches into the roof space away from moisture-producing areas, such as bathrooms or kitchens.

- That hatch covers must be effectively sealed.
- High levels of workmanship.

**Air tightness of ceilings**

Air leakage through gaps in a ceiling transfer more heat and moisture into the roof by convection than passes through the ceiling materials by diffusion. Sealing the ceiling is therefore an essential requirement when considering the design of the roof envelope.

Key design issues to consider are as follows:

- Avoid construction gaps.
- Avoid roof access doors or hatches in rooms that produce excessive moisture.
- Use a proprietary sealed loft hatch and frame, and seal correctly in accordance with the manufacturer’s recommendations.

There is advice found in BS EN 13141-1 Ventilation for buildings. Performance testing of components/products for residential ventilation. Externally and internally mounted air transfer devices:

- Seal all services and roof lights
- Use recessed light fittings rated IP60 to IP65 to BS EN 60529
- Seal the head of cavity walls to prevent the transfer of warm moist air into the loft

It is recommended that Designers should undertake a Condensation Risk Analysis in accordance with BS 5250 to determine the level of ventilation required.

7.9.3.2 Cold roof

The following suggest the correct positioning of vents and the precise amount of free airspace required for four types of 'cold roof' construction, in accordance with current Building Regulations and BS 5250.

These recommendations apply if a high water vapour resistance (type HR) underlay is used.

**Mono-pitch/lean-to roof**

If the roof space is 15° or less, a free airspace of 25,000mm<sup>2</sup>/m is required at the eaves or at low level (equivalent to a continuous 25mm opening). If the roof pitch is more than 15°, a free airspace of 10,000mm<sup>2</sup>/m is required at the eaves or at low level (equivalent to a continuous 10mm opening). A free airspace of 5,000mm<sup>2</sup>/m should also be provided at high level (equivalent to a continuous 5mm opening).

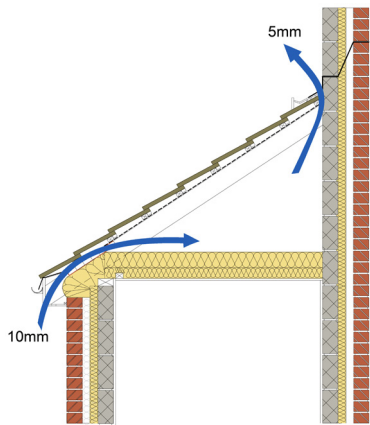

Figure 1: Mono-pitch/lean-to roof

**Duo-pitch roof A**

On each side of the roof, a free airspace of 10,000mm<sup>2</sup>/m is required at the eaves or at low level (equivalent to a continuous 10mm opening). If the roof space is 15° or less, a free airspace of 25,000mm<sup>2</sup>/m is required at the eaves or at low level (equivalent to a continuous 25mm opening).

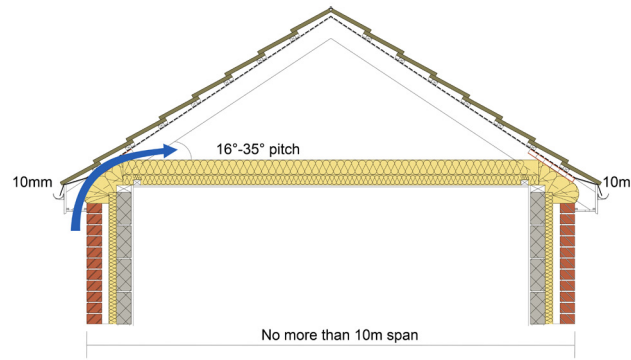

Figure 2: Duo-pitch roof A

**Duo-pitch roof B**

Where pitches are 35° or greater and spans are 10m or wider, a free airspace of 5,000mm<sup>2</sup>/m should also be provided at the ridge or at high level (equivalent to a continuous 5mm opening) to provide effective through-ventilation.

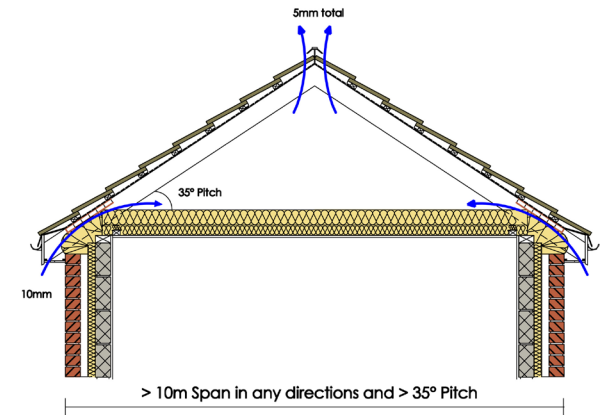
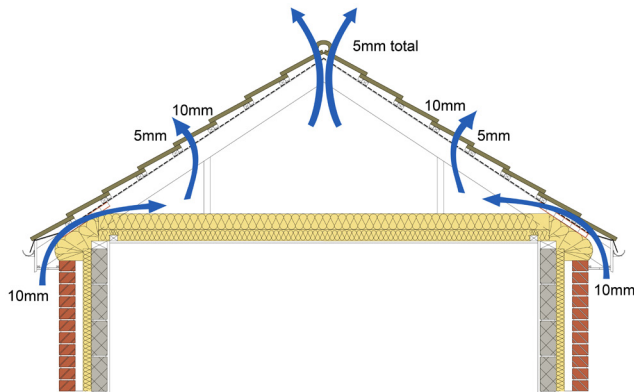

Figure 3: Duo-pitch roof B

**Duo-pitch roof with fire break walls**

This is similar to examples A and B, but with a firewall beneath each roof pitch. The roof now comprises three voids instead of one, and for the purposes of ventilation, each roof void is treated separately. The two smaller voids each require 10,000mm<sup>2</sup>/m of free airspace at the eaves or at low level, and 5,000mm<sup>2</sup>/m at high level below the firewall.

The larger void requires 10,000mm<sup>2</sup>/m of free airspace immediately above the firewall at low level, and 5,000mm<sup>2</sup>/m at the ridge or at high level (equivalent to a continuous 5mm opening) to provide effective through-ventilation.



**Figure 4: Duo-pitch roof with fire break walls**

**Vapour permeable (type LR) underlays**

If an LR underlay is used, interstitial condensation is unlikely to occur, provided the ceiling is well sealed and the eaves have a minimum continuous ventilation opening of 3mm. If the ceiling is not well sealed, openings equivalent to 7mm should be used; 10mm eaves vent systems will satisfy both requirements.

BS 5250 does not consider the situation where it is proposed to provide no ventilation to the roof void, or ventilation more limited than described above. Should Designers wish to adopt this principle, they should refer to the conditions attached to Technical Approvals given by UKAS (or European equivalent) accredited technical approval bodies.

**7.9.3.3 Roof with sloping ceilings**

The following illustrations suggest the correct positioning of vents and the precise amount of free airspace required for three types of ‘warm roof’ construction, in accordance with BS 5250.

**Duo-pitch roof**

On each side of the roof, a free airspace of 25,000mm<sup>2</sup>/m is required at the eaves or at low level (equivalent to a continuous 25mm opening). A free airspace of 5,000mm<sup>2</sup>/m should also be provided at the ridge or at high level on each slope (equivalent to a continuous 5mm opening). A minimum 50mm clear air path must always be maintained between the insulation and the underlay to ensure effective through-ventilation.

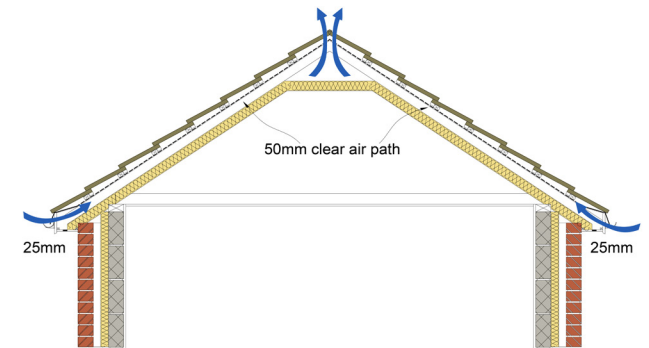
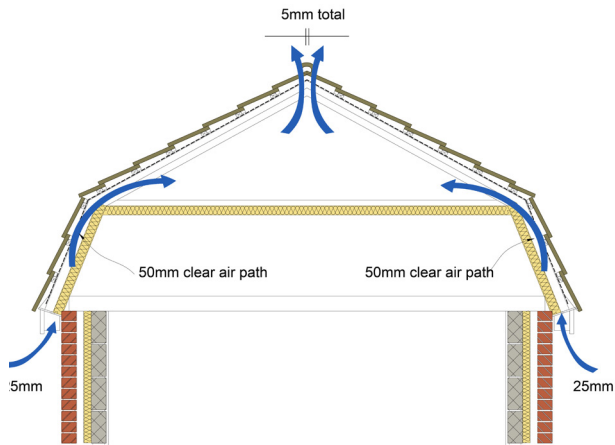

**Figure 5: Duo-pitch roof with sloping ceilings**

**Mansard roof**

Mansard ventilation is similar to that for duo-pitch constructions, requiring a free airspace of 25,000mm<sup>2</sup>/m on each side at the eaves or at low level (equivalent to a continuous 25mm opening), and 5,000mm<sup>2</sup>/m at the ridge or at high level (equivalent to a continuous 5mm opening).

A minimum 50mm clear air path must be maintained between the insulation and the underlay at mansard level to ensure effective through-ventilation.

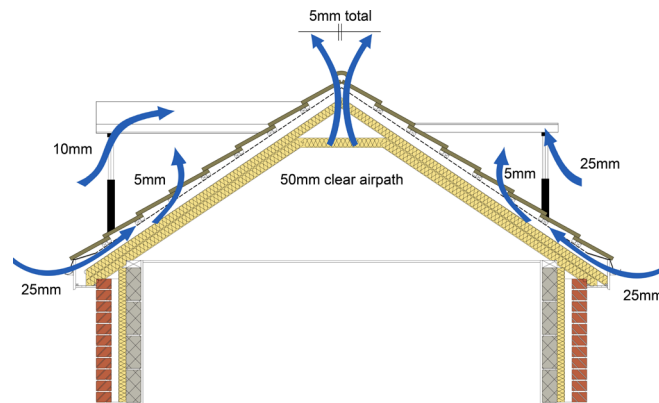

**Figure 6: Mansard roof**

**Pitched roof with pitched and flat dormers**

For the main roof, a free airspace of 25,000mm<sup>2</sup>/m is required at the eaves or at low level (equivalent to a continuous 25mm opening), plus 5,000mm<sup>2</sup>/m at the dormer sills and 5,000mm<sup>2</sup>/m on each side of the ridge or at high level on each slope (equivalent to a continuous 5mm opening). For dormers with cold pitched roofs, a free airspace of 10,000mm<sup>2</sup>/m is required at the dormer eaves (equivalent to a continuous 10mm opening). For dormers with flat roofs, a free airspace of 25,000mm<sup>2</sup>/m is required at the roof edges (equivalent to a continuous 25mm opening).

A minimum 50mm clear air path must always be maintained between the insulation and the underlay to ensure effective through-ventilation.



Where there is no cross communication between each roof slope, 5mm should be provided on both sides of the ridge

**Figure 7: Pitched roof with pitched and flat dormers**

**Tiled and slated roofs containing rooms**

These should be ventilated in accordance with Figures 5–7, but if an obstruction to a ventilation path occurs, such as fire-separating walls, additional ventilation openings should be provided:

- Immediately below the obstruction, equivalent to 5mm along the length of the obstruction.
- Immediately above the obstruction, equivalent to 25mm along the length of the obstruction.

**7.9.3.4 Warm roof construction**

Insulation may be provided above the rafter and between rafters to form a warm roof construction. The position of insulation and Vapour Control Layers (VCL) must strictly adhere to the insulation manufacturer's recommendations. All warm roof construction products must have appropriate third-party certification.

Ventilation to counter batten void will be required where vapour permeable (type LR) underlays are not used.

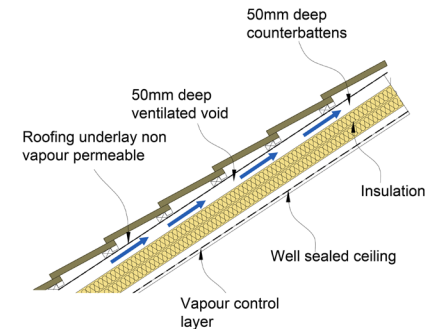

**Figure 8: Warm roof construction (vented battens)**

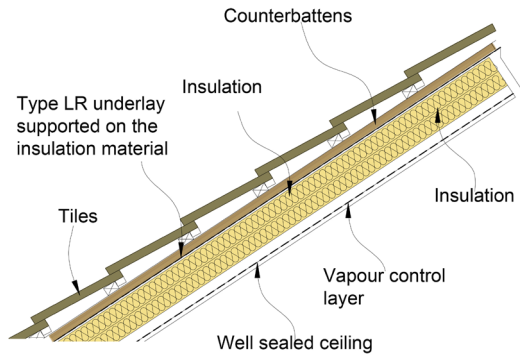

Figure 9: Warm roof construction (vapour breathable underlay)

## 7.9.4 Thermal insulation

### 7.9.4.1 Building Regulations

Thermal insulation must be installed to meet current Building Regulations, to an acceptable level of workmanship, to avoid cold bridges and to meet the following provisions:

- If required by BS 5250, use a vapour control plasterboard or a separate VCL behind the plasterboard.
- Use a proprietary eaves ventilator to ensure ventilation is in accordance with BS 525.0
- The use of over joist and under rafter insulation is considered best practice, as it eliminates the cold bridge caused by the joist/rafter.
- The installation of the eaves ventilator must not prevent free water drainage below the tiling battens.

### 7.9.4.2 Compliance

The requirements of the regulations are designed to reduce carbon emissions from new buildings and improve the performance of existing buildings where new work is carried out.

## 7.9.5 Materials

### 7.9.5.1 Underlay

#### Underlay nails

Nails for use with roofing underlays should be clout head nails of no less than 3mm shank diameter and 20mm length made of copper, aluminium alloy or steel coated by any of the zinc or zinc alloy coating methods specified in BS EN 10230-1.

#### Underlay

These types of underlay should comply with BS EN 13859-1 or have third-party accreditation, i.e. a BBA certificate.

There are two categories of underlay: HR, non-vapour permeable and LR, vapour permeable. These types of underlay should comply with BS EN 13859-1 or have third-party accreditation, i.e. a BBA certificate. They should also have sufficient tensile and nail-tear strength, and low extensibility, to produce the required resistance to wind uplift.

Underlays for use beneath tiles and slates are either fully supported over boarding, sheathing or sarking, or unsupported and draped over rafters/

counter battens, and should meet the conditions detailed in Figure 10.

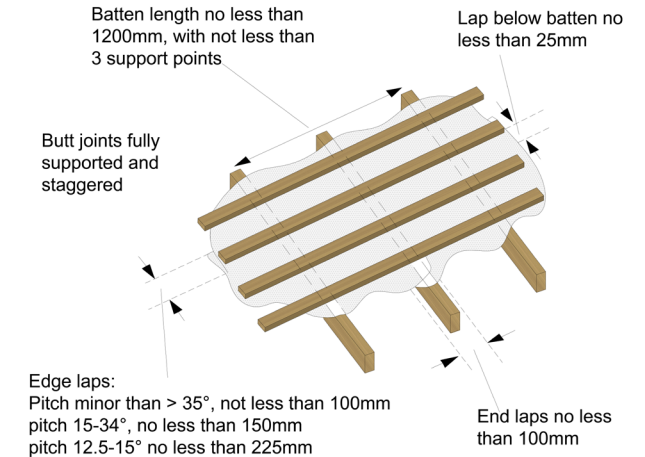

Figure 10: Roof underlay provision

#### Fully supported underlays

- BS 8747 Class 1B Bitumen (Fibre base)
- 2HR\* underlay to BS EN 13859-1 Class W1 water penetration classification with third-party certification for the use intended
- 3LR† underlay to BS EN 13859-1 Class W1 water penetration classification with third-party certification for the use intended



### Unsupported underlays

- BS 8747 Class 1F reinforced bitumen or Class 5U polyester reinforced bitumen.
- HR\* underlay to BS EN 13859-1 Class W1 water penetration classification with third-party certification for the use intended.
- LR† underlay to BS EN 13859-1 Class W1 water penetration classification with third-party certification for the use intended.

\* HR (high water vapour resistance) underlay - >0.25MN.s/g

† LR (low water vapour resistance) underlay - <0.25MN.s/g

(LR underlays are sometimes referred to as 'vapour permeable' or 'vapour open')

### Vapour Control Layer (VCL)

If a VCL is installed it should be placed on the warm side of the insulation. Installation of a VCL at ceiling level will increase the need for sufficient ventilation below it during the drying out of wet trade construction phases. The performance of a VCL depends not only on the material selected, but also on the workmanship and the ability of the construction to be assembled on-site (see BS 5250). It is essential that a VCL be adequately lapped and all joints sealed, and that its integrity is maintained. Particular attention should be paid to detail design and installation around penetrations through the VCL, e.g. services, compartment walls and to the sealing of punctures caused by fixings.

### 7.9.5.2 Timber battens

#### Timber species

Tiling battens and counter battens should be selected from the timber species set out in BS 5534, and their characteristics and defects should not exceed the permissible limits given in Annex C of BS 5534.

#### Sizes

Timber battens should be graded and marked in accordance with BS 5534. Timber batten sizes should be not less than the minimum values recommended in BS 5534 for the common applications listed therein.

#### Other sizes

Battens for large spans or special loading conditions should be designed by structural calculation for strength and stiffness, in accordance with Annex E of BS 5534.

#### Preservatives

BS 8417: 2011 provides recommendations for preservatives for timber. Indicative preservative treatment schedules are given in Annex D of BS 5534. Battens treated with preservatives can contain toxic substances that could introduce an environmental hazard, and should be disposed of safely.

### 7.9.5.3 Tile and slate fixings

BS 5534 recommends the use of aluminium or stainless steel nails under normal conditions of exposure. Plain or galvanised nails may be used for fixing battens to rafters, but care must be exercised when there is high humidity as certain timber preservative treatments may corrode steel, zinc or aluminium.

#### Tile nails

Nails for use with tiles should be of copper, aluminium, stainless steel, phosphor or silicon bronze. Aluminium nails intended for use with tiles should conform to BS 1202-3 and should be clout head nails of 3.35mm or 2.65mm diameter. The length of nail will be determined by the required wind uplift and the design of the tile. Stainless steel nails for use with tiles should conform to BS 1554 grade 302, 304, 315, 316, 321 or 347, and should be specified for coastal areas, areas of high exposure or where there is a risk from chemical reaction.

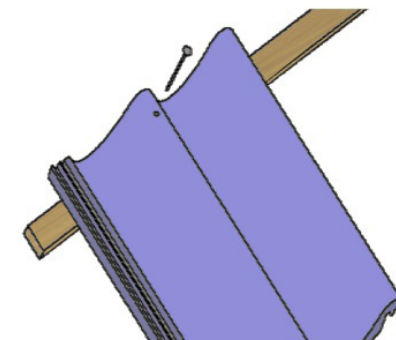

Figure 11: Nailing tiles to battens

**Tile clips**

Located over the side lock of the tile immediately behind the overlapped tile, and nailed to the tiling batten, tile clips provide resistance to the applied overturning moment more successfully than a nail fixing. The latter is closer to the pivot line, where the nib touches the batten and cannot resist the uplift force at the tail. The phenomenon is also related to roof pitch and the step height of the roof covering, and BS 5534 acknowledges that, at roof pitches of 45°–55°, all tiles should be at least nailed to battens to prevent displacement. At pitches exceeding 55° all tiles must be both head nailed and tile clipped to reduce ‘chatter’ in high winds.

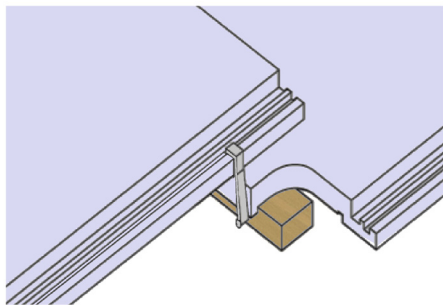

Figure 12: Tile clips

**Slate nails and rivets**

Nails intended for use with fibre cement slates should be of copper, conforming to the requirements for clout nails specified in BS 1202-2. The shank diameter and length should be determined by the exposure of the site and

the nail’s withdrawal resistance. Normally, 30mm x 2.65mm copper nails are adequate for most applications. For exposed sites, or where aggressive environments are encountered, contact the slate manufacturer. Copper disc ‘tail’ rivets are used to further secure the tail of fibre cement slates against wind chatter.

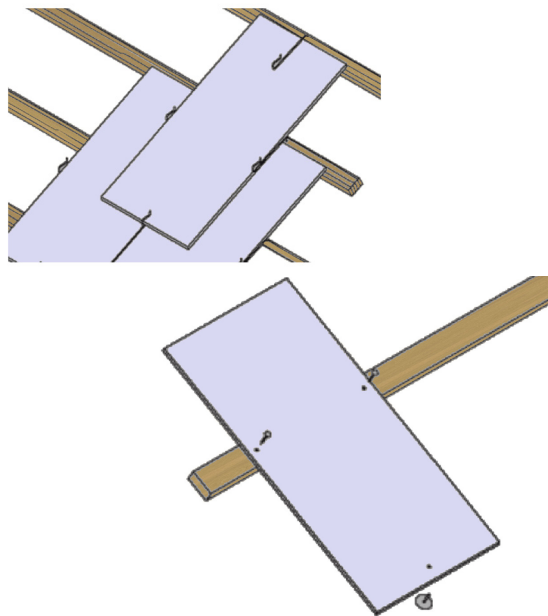

Figure 13: Fixing slates

**Slate hooks**

Hooks are formed from stainless steel wire conforming to BS 1554 grade 316 S11 or 316 S19. For further advice on the use of slate hooks, refer to BS 5534 Section 4.13.3 Hooks and rivets for slates.

**7.9.5.4 Flashings and weatherings**

Lead is generally ideal for roofing purposes; it is easily dressed over complicated shapes using simple hand tools, and can be joined by soldering or lead burning. For most roofing purposes, Codes 3, 4 and 5 will be adequate, but for extreme conditions of exposure, thicker codes may be necessary.

Lead sheet used for roofs, flashings and weatherings should, in terms of suitability to meet the requirements of the Technical Manual, be in accordance with BS EN 12588 or a valid UKAS (or European equivalent) third-party accreditation (e.g. British Board of Agrément, BRE, etc.) that demonstrates adequacy and durability for use (see Chapter 2.3.5).

**Clips**

Clips for flashings are important in all roofing applications, and where used should be fixed at 300mm–500mm centres, depending on the exposure of the building.

Clips may be formed from the following materials:

- **Lead:** Only suitable for sheltered locations with a thickness the same as that of the flashing it is fixing.
- **Copper:** Should be a minimum of 0.6mm thick, and may be thicker for very exposed locations.

- **Stainless steel:** Should be 22swg or 28swg thick, and is used for very exposed locations or where the fixing point is more than 75mm from the free edge of the flashing.
- **Nails and screws:** Copper wire nails (with jagged shanks) should be a minimum 25mm long x 10 gauge. Stainless steel annular ring shank wire nails should be a minimum 25mm long x 12 gauge. Screws should be brass or stainless steel, minimum 25mm long x 10 gauge.

### 7.9.5.5 Mortar

The mortar used in roof construction should conform to the recommendations given in BS 5534. Mortar should typically consist of a cement and sand mix based on sharp sand, with soft sand added to achieve workability. The proportion of sharp sand should not be less than a third of the total sand content.

Alternative proprietary mortar mixes may be accepted if they are shown to have similar strength, durability and workability.

### 7.9.6 Workmanship

#### 7.9.6.1 Slate and tile fixing

Slate and tile fixing should be in accordance with BS 8000-6.

#### 7.9.6.2 Fixing timber batten

Battens and counter battens should be graded to meet requirements recommended in BS 5534 in respect to timber species, permissible characteristics and defects and preservative treatment. Battens should be at least 1200mm in length and supported at each end and intermediately by at least three rafters, trusses or walls. Stagger butt joints over intermediate supports, splay nail each batten end and nail battens to each rafter.

On trussed rafter roofs for interlocking tiles, allow no more than one joint in any four consecutive battens on the same support. On trussed rafter roofs for plain tiles, allow no more than three joints together in any twelve consecutive battens on the same support. The batten sizes given in Table 2 should be taken as minimum dimensional requirements. Take care that nails used to secure tiles do not penetrate the underside of battens or the underlay.

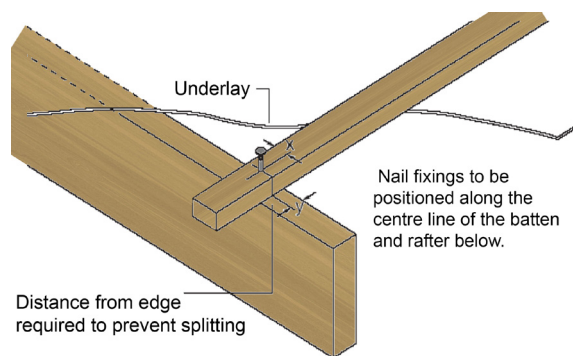

Figure 14: Fixing battens to rafters

Recommended batten sizes for pitched roofs and vertical work (BS 5534 in accordance with clause 4.12.4.1).

Tile type	Basic minimum sizes*			
	450mm span		600mm span	
Rafters/ supports	width	depth	width	depth
Plain pitched/vertical	38	25	38	25
Single lap interlocking tiles/slate	38	25	50	25
Fibre cement slates	38	25	50	25

\*All dimensions subject to re-sawing allowance: width + 3mm depth - 0 or + 3mm based on measurement at a reference moisture content of 20%.

Table 2: Minimum sizes of timber battens

#### Fixing roof battens

Fix the specified battens up the roof slope on top of the rafters, ensuring a minimum 40mm nail penetration into rafters (smooth shank). Nail counter battens at maximum 300mm centres vertically up the roof slope where boarding is used to coincide with the line of rafters.

#### Fixing wall battens

Fix the specified battens to boarding/sheathing/sarking in line with vertical supports, or to a masonry wall as specified. Secure counter battens to masonry walls with improved nails or with plugs and screws.

7.9.6.3 Underlays

Lay the specified roofing underlay parallel to eaves or ridge with horizontal overlaps, as specified in Table 3. Vertical side laps should be a minimum of 100mm. Minimise the gap at laps resulting from different tautness between underlay courses. Drape in underlay between supports is to be no less than 10mm and no greater than 15mm. Fix underlay with the fixings specified, keeping the number of perforations to a minimum. Handle and fix underlay with care to ensure there are no tears or punctures, and repair any tears or punctures prior to tiling. Ensure that the underlay does not obstruct the flow of air through ventilators located at eaves, ridge or in the main roof, and appropriately weather all holes formed in underlays for soil vent pipes, etc. Avoid contact between the underlay and the underside of tiles, while to prevent wind uplift, fix additional battens or timber strips where laps occur between tiling battens.

Minimum horizontal lap for underlays (BS 5534 in accordance with clause 6.2.1.1):

Rafter pitch	Not fully supported (mm)	Fully supported (mm)
12.5° to 14°	225	150
15° to 34°	150	100
35° and above	100	75

Table 3: Minimum horizontal laps for underlays

7.9.7 Slate and tile details – key check points

7.9.7.1 Eaves and bottom edge (In accordance with BS 5534 and BS 8000-6)

At the eaves (bottom edge), the batten should be set to provide the required overhang of the tiles, slates or shingles into the gutters. The recommended overhang is 45mm–55mm horizontally, or to the centre of the gutter, whichever is less.

- Ensure fascia board is to correct height so as to prevent tiles/slates kicking up or drooping.
- Fit duct trays to retain insulation.
- Fix underlay protector trays, fascia vents and comb fillers (profiled tiles).
- Clip eaves course where required.
- Ensure vent path to roof space is achieved.

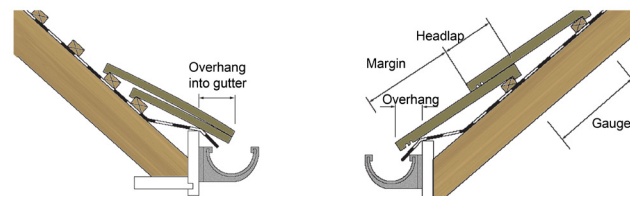

Figure 15: Eaves and bottom edge details

7.9.7.2 Verge (in accordance with BS 5534 and BS 8000-6)

Battens should overlap onto the outer skin of the brickwork or the undercloak material; for plain tiles, the verge should project 38mm–50mm; interlocking tiles can project 30mm–60mm. Where the distance of the nearest batten fixing to the rafter is greater than 300mm, an additional mechanical fixing is recommended.

**Note:** Where proprietary verge tiles or systems are specified, the detailing should be in accordance with manufacturers' recommendations that are relevant to UK conditions of use.

- Use recommended undercloak for mortar.
- Level off irregularities in brickwork.
- Carry underlay over gable wall or bargeboard, and fit undercloak.
- Use the correct mortar mix.
- Bed and point tiles in one operation.
- Keep mortar clear from the ends of tiling battens.
- Fix all perimeter tiles and slates (clip and/or nail).

Undercloak

Where an undercloak is used, it should comprise plain tiles, slates or fibre cement sheet strip. It is usually fixed at verges beneath the battens and on top of the underlay to support the mortar onto which the verge tiles or slates are bedded.

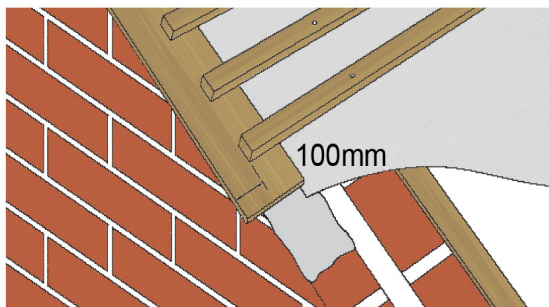

Figure 16: Verge detail

### 7.9.7.3 Valley (In accordance with BS 5534 and BS 8000-6)

The design of pitched valley gutters is just one roof detail where the latest guidance is much improved over previous Codes of Practice. The valley is the most vulnerable area of a pitched roof in respect to potential water ingress, as it drains all of the water from adjacent roof slopes.

Consequently, the design data is related to the pitch of the roof, the rainfall rate, the length of the valley and the catchment area or area of the roof to be drained. Designers are able to determine the width of valley trough appropriate for discharging the rain water from the adjacent roof covering to the eaves gutter.

- Check roof pitch, area to be drained and rainfall rate to determine width of valley gutter.
- Consider length of valley when choosing proprietary valley troughs (over 8m).
- Ensure ground work provides adequate

- support for valley lining; make flush with top of rafter.
- Do not place bitumen underlay beneath lead sheet valley.
- Keep open gutter width 100mm–250mm (correct width to be determined by reference to Table 14 in BS 5534).
- Keep roof design as simple as possible.
- Avoid discharge of valleys onto roofing wherever possible, but where inevitable use a lead saddle.
- Avoid direct contact with lead when using mortar; provide a fibre cement undercloak or tile slips.
- Do not block tile laps with mortar to avoid water damming.
- Mechanically fix all tile and slates adjacent to valleys.

### 7.9.7.4 Ridge (in accordance with BS 5534 and BS 8000-6)

The ridge or top course batten should be set to allow the ridge tiles, ridge units or metal ridge to overlap the top course of tiles, slates or shingles by the overlap necessary for the main tiles, slates or shingles. For interlocking tiles, this should be not less than 75mm. For double-lap products, the top batten should be set to allow the ridge to overlap the penultimate course by the required head-lap.

- Check ridge tile is suitable for pitch of roof.
- Edge bed components onto tiles or slates.
- Ensure top course tiles or slates are mechanically fixed.
- Mitre tiles neatly at hip ridge junctions, and use a lead saddle underneath for protection.

- Use the correct mortar mix.
- Use dentil slips in deep profiled tiles in all joints more than 25mm thick to reduce mortar and risk of shrinkage.
- **All** mortar bedded ridge tiles **must** also be mechanically fixed by proprietary fixings in accordance with the roof covering manufacturer's recommendations.

**Note:** Dry fix ridge systems are available to provide full mechanical fixing of all ridge and hip tiles to meet BS 5534 recommendations.

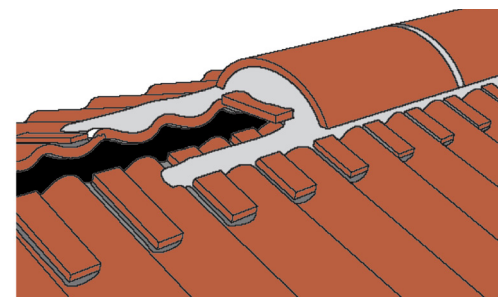

Figure 17: Ridge detail

### 7.9.7.5 Hip (in accordance with BS 5534 and BS 8000-6)

- Check hip tile is suitable for pitch of roof.
- Mitre tiles neatly at hip ridge junctions and use a lead saddle underneath for protection.
- Use the correct hip iron at base of hip.
- Use the correct mortar mix.
- Use dentil slips in deep profiled tiles in all joints more than 25mm thick to reduce mortar and risk of shrinkage.
- **All** mortar bedded hip tiles **must** also be mechanically fixed (screws, nails, clips, etc.).

**Note:** Dry fix ridge systems are available to provide full mechanical fixing of all ridge and hip tiles to meet BS 5534 recommendations.

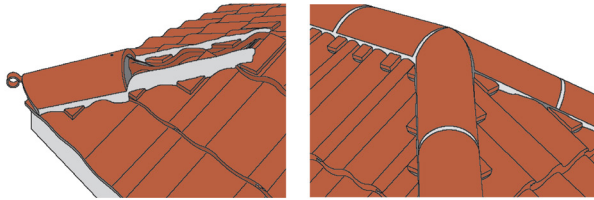

Figure 18: Hips

### 7.9.7.6 Flashings and weatherings

The following is a brief summary of metal flashing details; for the best advice on the use of lead, reference may be made to the Lead Sheet Association or the metal flashing manufacturer's recommendations.

A coat of patination oil should be applied to lead flashings after fixing. Lead can be used in contact with other metals, such as copper and stainless steel, without risk of bimetallic corrosion, but should not be used with aluminium in a marine or coastal environment.

Lead sheet used for roofs, flashings and weatherings should, in terms of suitability to meet the requirements of the Technical Manual, be in accordance with BS EN 12588 or a valid UKAS (or European equivalent) third-party accreditation (e.g. British Board of Agrément, BRE, etc.) that demonstrates adequacy and durability for use (see Chapter 2.3.5).

### Interlocking tile

#### Side abutment

There are three common ways of weathering a side abutment with interlocking tiles; stepped cover flashings, secret gutters and a combination of stepped cover flashing above secret gutter.

#### Side abutment: (stepped cover flashing)

- Turn roofing underlay a minimum of 50mm up at the abutment.
- Finish the tiling battens as close to the abutment as possible.
- Lay the tiles to butt as close as possible to the wall.
- Cut a piece of Code 4 lead to form a combined step and cover flashing.
- Flashing should not exceed 1.5m in length, and should be 150mm–200mm in width or wide enough to cover the first roll, whichever gives the greater cover.
- Chase out brickwork mortar joints and push folds of flashing into chases; wedge in with small pieces of lead.
- Dress cover flashing as tightly as possible to tile profile.
- Repoint brickwork.
- In areas of high exposure, or when dressing lead over flat tiles, use clips to hold cover flashing in place; when using this type of flashing with flat tiles below 25°, increase cover of flashing over tile to 200mm.

#### Side abutment: (secret gutter; with and without cover flashing)

A secret gutter may be formed as an alternative to a step and cover flashing when using single-lap flat interlocking tiles and slates. In view of the increased risk of water penetrating under the lead, especially on low pitches in exposed locations, maximum security can be achieved using a combination of both secret gutter and cover flashing.

- Form secret gutters before starting tiling.
- Fix a support between the last rafter and the abutment; this should be a minimum of 75mm wide and run the full length of the abutment.
- Fix a splayed timber fillet at the discharge point to raise lead lining to the right height; avoid backward falls.
- Fix a counter batten along the outer edge of rafter.
- Line gutter with Code 4 or 5 lead, in lengths of no more than 1.5m.
- Lap each strip offered over the lower one by a minimum of 150mm, and fix with copper nails at head.
- Turn up lead welts to provide a weather check and exclude birds and vermin from entering tile batten space.
- Gutter should be a minimum of 25mm deep and have a vertical upstand of no less than 65mm above the top surface of the tiles or slates.
- Fit a stepped flashing, chased into brickwork as before and dressed over vertical upstand.
- Turn roofing the underlay up the side of the counter battens and butt the tiling battens up

## CHAPTER 7: Superstructure

- to the counter batten.
- Lay tiles to leave a gap of 15mm by the side of the abutment.
- A lead cover flashing above the secret gutter is advisable for interlocking tiles and slates, particularly in areas of high exposure or on roofs under trees, where the risk of blockage is high. If this is done, the width of the secret gutter may be reduced to 50mm.

### Top edge abutment

- Turn roofing underlay a minimum of 50mm up at the abutment.
- Fix the top tiling batten as close as possible to the abutment.
- Complete tiling in the usual way.
- Chase abutment and insert lengths of code 4 lead, no more than 1.5m long; wedge in with small pieces of lead, no less than 450mm apart.
- Lead should be wide enough to give at least 150mm cover to top course of tiles, e.g. below 30° this increases to 290mm at 15° rafter pitch.
- Vertical upstand should be 75mm–100mm.
- Lap each length of lead by no less than 100mm.
- Dress lead to the profile of the tiles.
- Secure lead flashings with copper or stainless steel clips, with frequency dependent on exposure (see the Lead Sheet Association recommendations).

### Double lap plain tiles

#### Side abutment: (soakers and step flashings)

Soakers are used where double-lap plain tiles abut a wall.

- Turn underlay 50mm up the abutment and cut tiling battens 10mm–25mm short of the wall and fix securely.
- Lay tiles close to the abutment with a soaker fitted between each tile.
- Form code 3 lead soakers with an upstand of 75mm to place against the abutment. They should be 175mm wide and 190mm long, allowing a 25mm downturn over the back of the tile. After all tiles and soakers have been fixed, insert a stepped flashing into the abutment wall and dress down over the upturned edges of the soakers.

### Fibre cement and natural slates

#### Side abutment: (step and cover flashing with soakers)

- Continue the underlay across the roof and turn up the wall by a minimum of 50mm. Cut the battens 10mm–25mm short of the wall, and fix securely.
- Finish the slating with alternate courses of slates and slate-and-a-half slates, cut as necessary to maintain the bond.
- Code 3 lead soakers, with a minimum width of 175mm and length equal to gauge + lap + 20mm, are to be interleaved with the slates and turned 75mm up the wall.

- The Code 4 stepped lead flashing should be secured in the brickwork bed joints with lead wedges and dressed neatly over the soakers.

### Top edge abutment flashings

- Continue underlay a minimum of 50mm up the wall.
- Position two battens downslope from the abutment, the upper to receive the top edge of the top course slate and the lower the top of the full length slate.
- Head nail the top course slate and use a disc rivet to secure the tail in the usual manner. Centre nail and rivet the full length slate below in the normal way.
- Dress Code 4 lead cover flashing over the top course slates and turn up the wall face a minimum of 100mm, with the top edge turned into the brickwork bed joint and secured with wedges.
- Extend lead down over the slate to lap the surface a minimum of 150mm, and secure the bottom edge with a clip to resist wind uplift.

### Dormers

Treat tiled dormer roofs in a similar way to the main roof work. However, single-lap tiling is less suitable for small covered areas, and for a dormer, it is generally preferable to adopt an alternative form of covering.

When dormer cheeks are tile hung, close cut vertical tiles to the roof rake over a flashing fixed to the side of the dormer, and dress well into the

adjacent tiles. The formation of a secret gutter is not recommended.

### Back gutters

Back gutters may be lead welded off-site and positioned when tiling is undertaken. A gutter should be formed where the bottom edge of tiling meets an abutment. Form the gutter before tiling, but after felting and battening is complete.

- Fix a lay board to support lead lining, with a tilting fillet, close to the abutment to flatten the pitch of the lead.
- Dress a sheet of Code 5 lead (width of abutment plus 450mm) into position with a vertical upstand of at least 100mm up the abutment.
- Dress the extra width of lead around the corner of the abutment after any side abutment weathering has been fitted.
- Dress the upper edge of lead over the tilting fillet and turn it back to form a welt.
- Chase abutment, insert a cover flashing of Code 4 lead and dress it over the vertical upstand of the gutter.

### Roof protrusions

The treatment of tiling against chimney stacks, skylights and other similar projections through the roof surface should be similar to that described for abutments where appropriate.

- Make perforations for pipes, chimney stays, supports for ladders, etc. weather tight by dressing over and under tiling with a lead or

- copper slate to which a sleeve is burned or soldered
- Boss sleeve around pipe or stay, and seal at top with a collar

### Saddles

The following details can apply to any type of valley or hip /ridge intersection:

- Use Code 4 lead no less than 450mm square and large enough to give a lap of at least 150mm over the gutter lining on each side.
- Saddles should be capable of being readily dressed down when in position.

#### 7.9.7.7 Vertical tiling and slating

##### Vertical slating with fibre cement slates

Fibre cement slates can be fixed to vertical surfaces and provide an attractive and weather proof cladding on both timber frame and masonry constructions.

The following guidance notes apply to this detail:

- Use counter battens over masonry construction (38mm x 25mm minimum) to reduce direct fixing. Special masonry fixings may be required.
- Slate-and-a-half should be used in alternate courses at internal and external corners and adjacent to openings.
- Use Code 3 lead soakers to weather internal and external corners.

- Fix slates by two nails and one rivet, and slate-and-a-half by three nails and two rivets.
- Code 4 lead cover flashings should be used above and below openings, in accordance with Lead Sheet Association recommendations.

### Vertical tiling with plain tiles

Plain tiling is an excellent, weather proof and attractive cladding to the vertical walls of any building. Feature and ornamental tiles may also be used with normal plain tiles to create decorative patterns. Fibre cement slates can also be used for vertical cladding.

- Use counter battens over masonry construction (38mm x 25mm minimum) to reduce direct fixing. Special masonry fixings may be required.
- Ensure tiling details do not interfere with the opening of windows and doors.
- Lead flashings and soakers should be used around openings, in accordance with Lead Sheet Association details.
- Use double course of tiles at eaves, by laying first course of eaves/tops tiles with course of full tiles laid over.
- At the top of a wall or under a sill, use a course of eaves/tops tile laid over a course of full tiles. Dress a Code 4 lead cover flashing over by 100mm.
- Use internal and external angle tiles at all 90° corners. Purpose-made 135° angle tiles are also available. For other angles, close mitre tiles and use Code 3 lead soakers
- All tiles should be twice nailed.



### 7.9.7.8 Dry fix systems

Proprietary dry roofing products and systems may be used as an alternative to mortar bedding at verges, ridges, hips and valleys to provide weathering and mechanical resistance properties. Dry roofing products as fitted should not adversely affect the performance of the roof as laid.

Specifiers should seek evidence that this will not be the case, and should use dry roofing products only if such evidence is available.

**Note 1:** There are no British Standards for these products. Specifiers should seek evidence of third-party testing.

**Note 2:** Users should pay particular attention to the resistance to wind load and durability performance of dry roofing products.

### Appendix

#### British Standards:

BS EN 490  
BS EN 492  
BS EN 1304  
BS 5250  
BS EN 1990: 2002+A1  
BS 5534: 2003+A1  
BS EN 1991-1-4: 2005+A1  
BS 8000-6  
EN 13859-1  
BS 6399-2

### Further guidance

NFRC Zonal Method User Guide (available from the NFRC website [www.nfrc.co.uk/](http://www.nfrc.co.uk/))

Practical guidance on the application of single-lap and double-lap tiling can also be obtained from CITB/CS Trainer Resource Package for Operatives in the Construction Industry Manuals, Construction Industry Training Board, 2002:

- CTP 036/1 – Roof Slating and Tiling – Common Materials and Methods
- CTP 036/2 – Roof Slating and Tiling – Single-lap, Variable Gauge, Interlocking Tiles
- CTP 036/3 – Roof Slating and Tiling – Double-lap, Variable Gauge, Plain Tiles
- CTP 036/5 – Roof Slating and Tiling – Single-lap, Fixed Gauge, Interlocking and Mitred Tiles